

Q145 答え

A サーカス

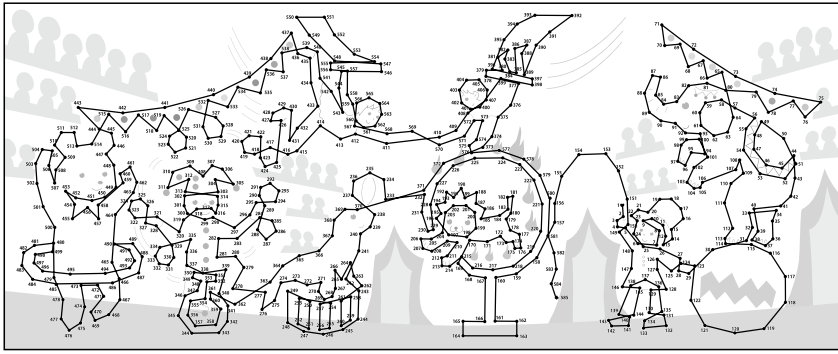

Q146 答え

B 気球

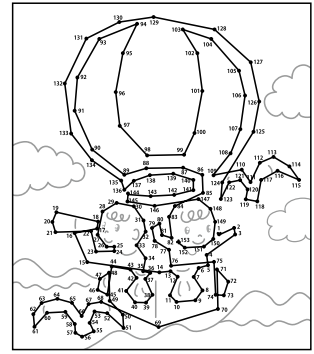

Q147 答え

A ホルン

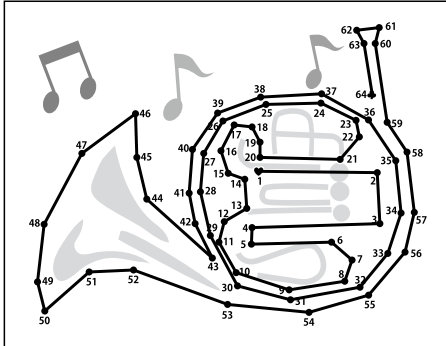

Q148 答え

B 琴

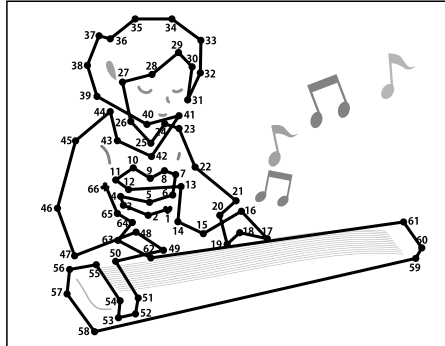

Q149 答え

C なべ

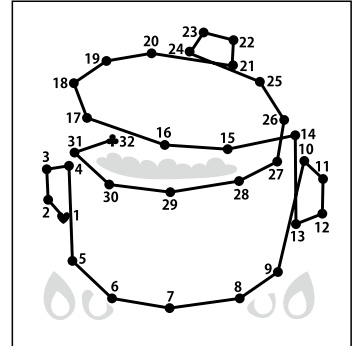

Q150 答え

B リボン

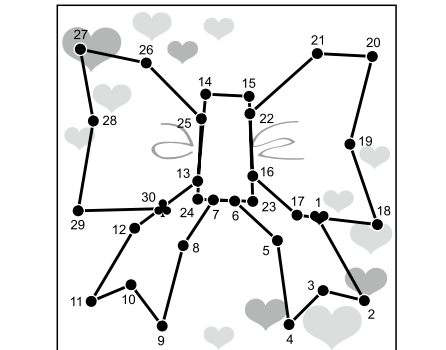

Q151 答え

B 椅子

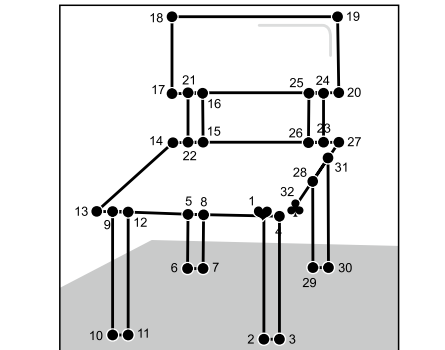

Q152 答え

A 絞り器

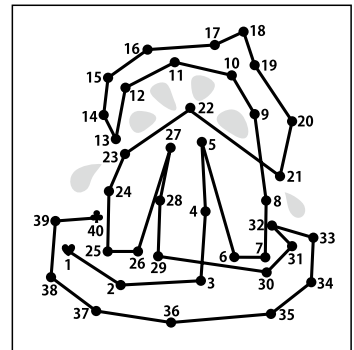

Q153 答え

C ワニ

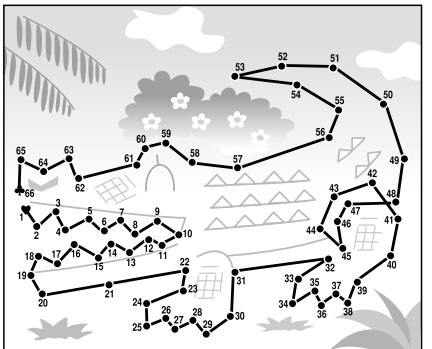

Q154 答え

A プテラドン

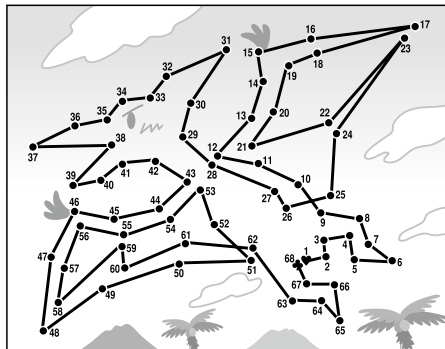

Q155 答え

A バス

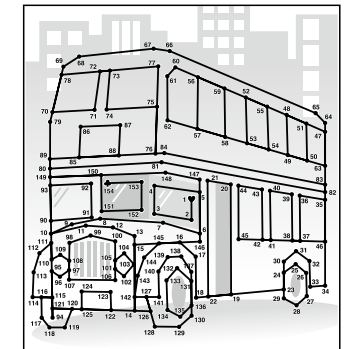

Q156 答え

A 伝書鳩

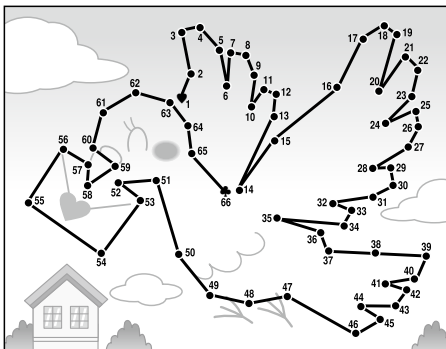

Q157 答え

C ほうき

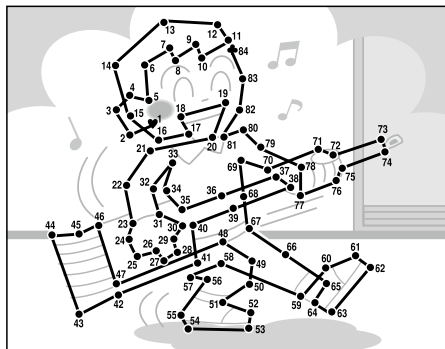

Q158 答え

A イルカ

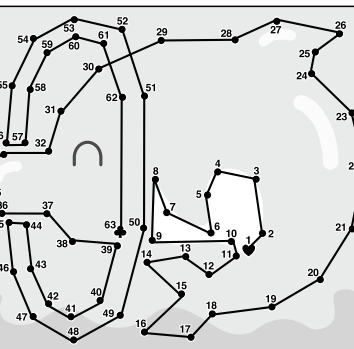

Q159 答え C サル

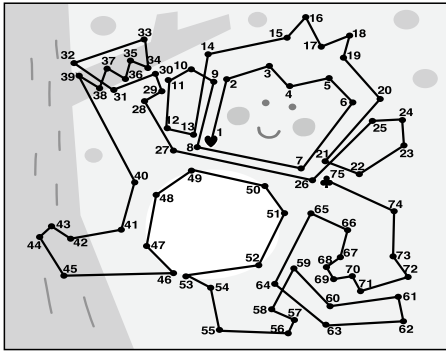

Q160 答え A だるま

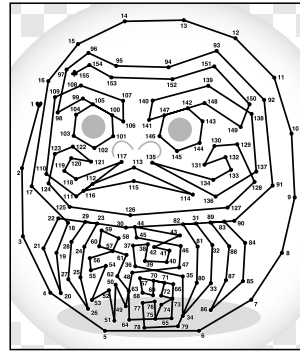

Q161 答え B クマ

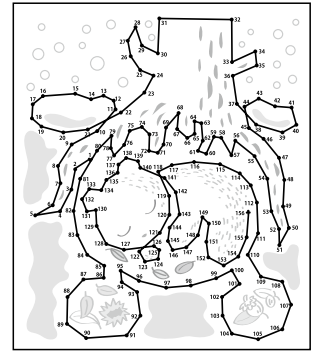

Q162 答え C 桜

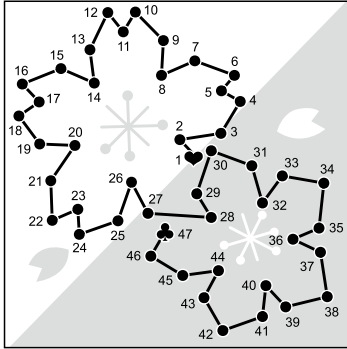

Q163 答え C ピーラー

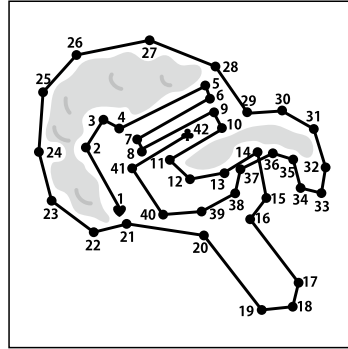

Q164 答え A チューリップ

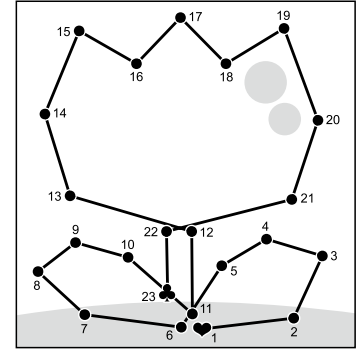

Q165 答え A つくし

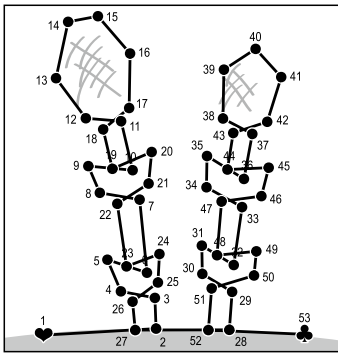

Q166 答え A ピッチャー

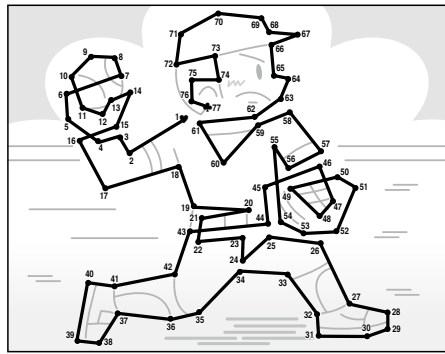

Q167 答え B バッター

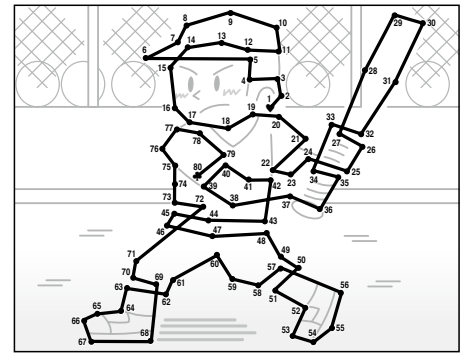

Q168 答え C 扇子

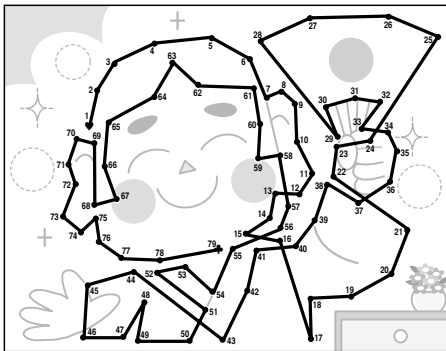

Q169 答え C 鬼

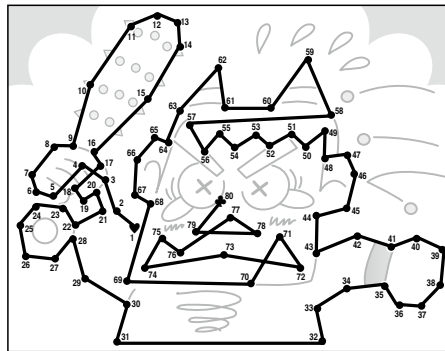

Q170 答え A 買い物かご

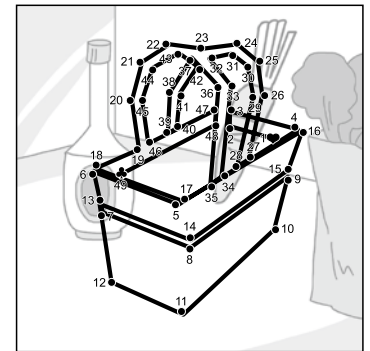

Q171 答え B シャツ

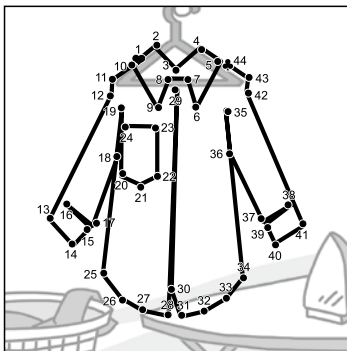

Q172 答え B 時計

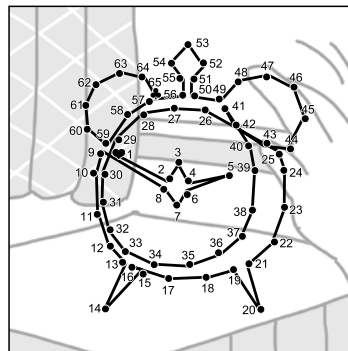

Q173 答え A 急須

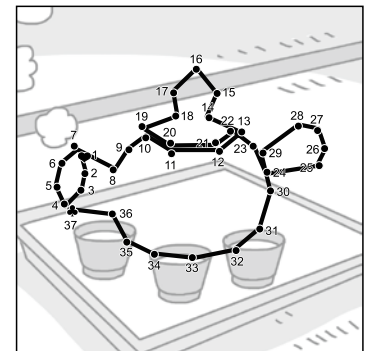

Q174 答え

B



Q175 答え

B (加齢/華麗→「カレイ」)

Q176 答え

C (「たちつと」の「て」が「み」→手紙)

Q177 答え

B (身体が火照る→「ホテル」)

Q178 答え

B (島の中に穴→し「ろく」ま→「シロクマ」)

Q179 答え

C 人魚

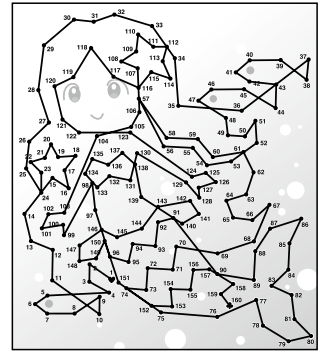

Q180 答え

C バラ

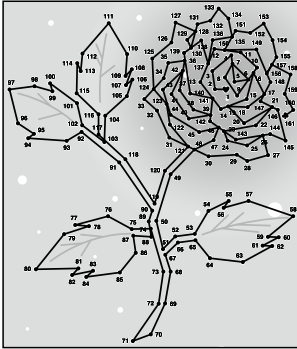

Q181 答え

A トーテムポール

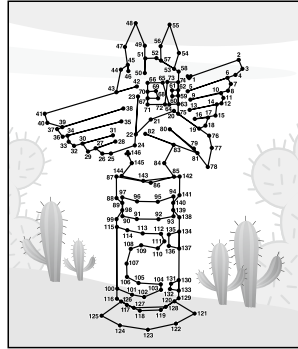

Q182 答え

C 5匹

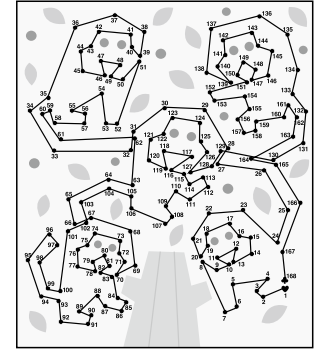

Q183 答え

A ウサギとニンジン

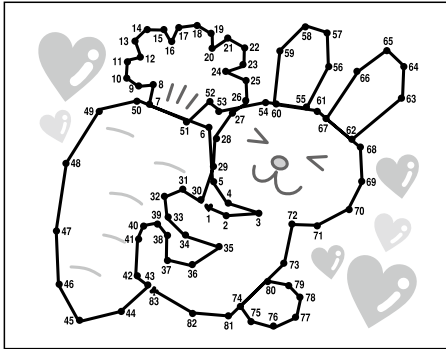

Q184 答え

C タクシー

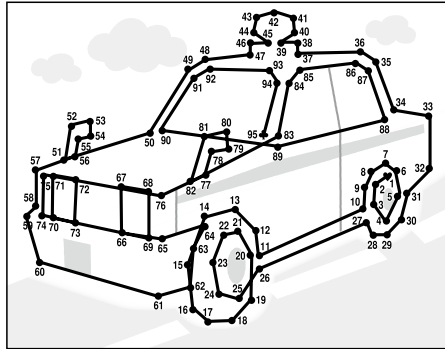

Q185 答え

B スイカ

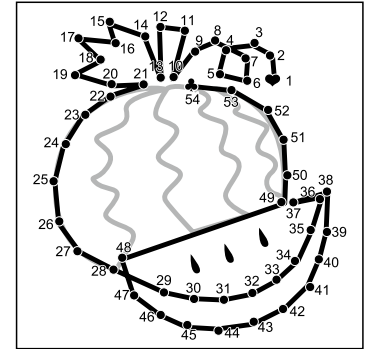

Q186 答え

A パイナップル

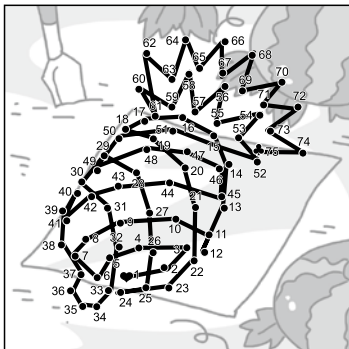

Q187 答え

A 泡立て器

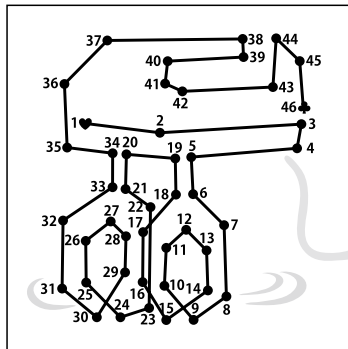

Q188 答え

C カップケーキ

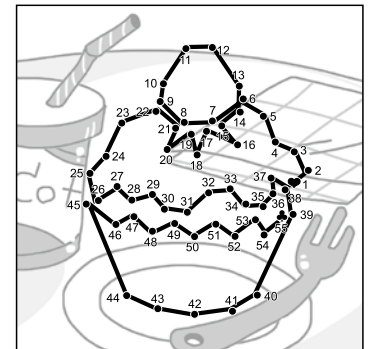

Q189 答え

D 流しそうめん

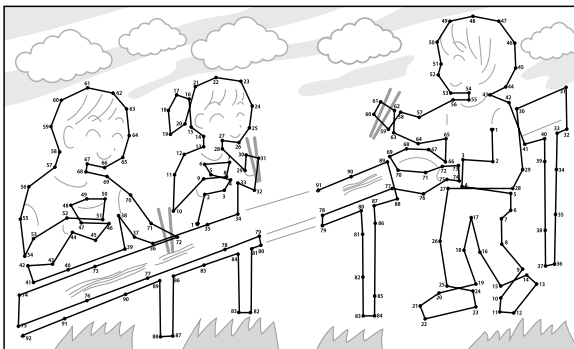

Q190 答え

C 東京都

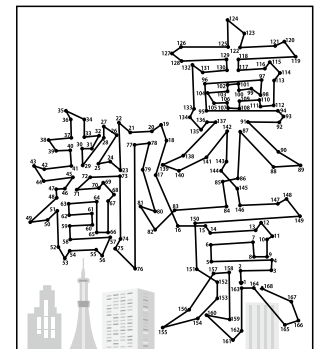

Q191 答え B ハンドソープ

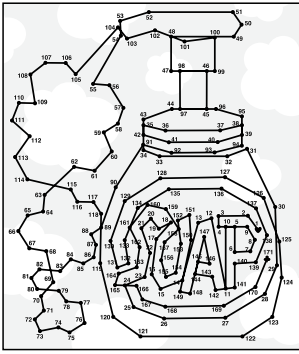

Q192 答え B 埴輪 (はにわ)

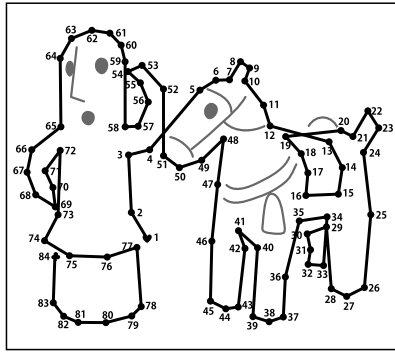

Q193 答え C 土偶

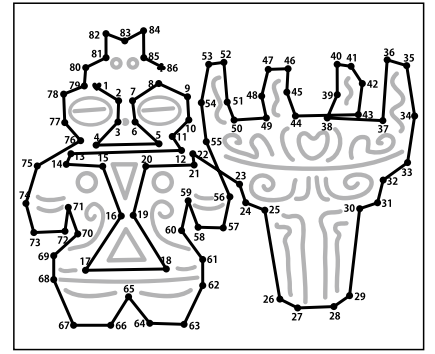

Q194 答え B 金太郎の勝ち

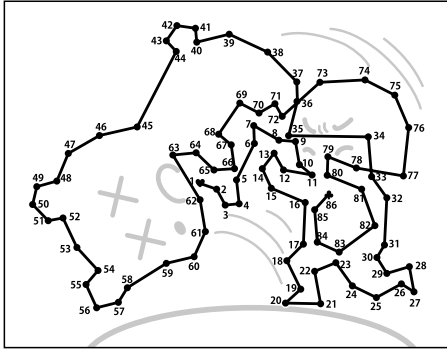

Q195 答え C ねずみ

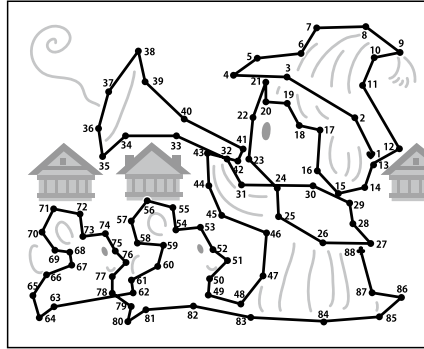

Q196 答え A バレエ

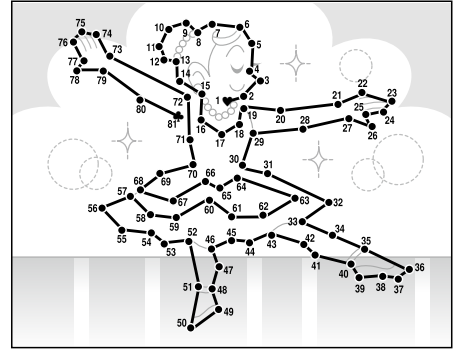

Q197 答え B バッタ

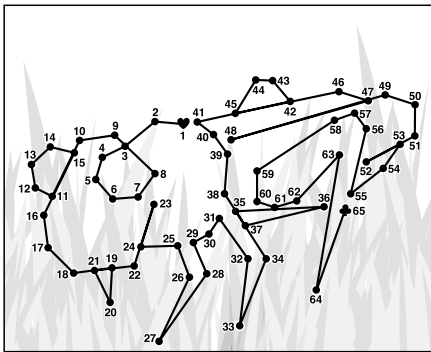

Q198 答え B ハンバーガー

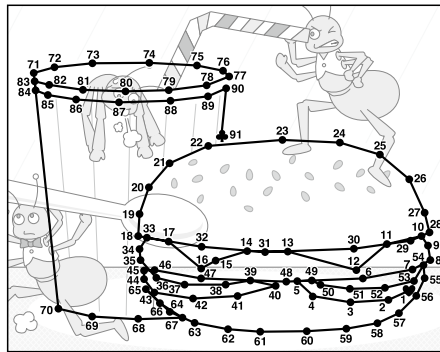

Q199 答え A シャンパン

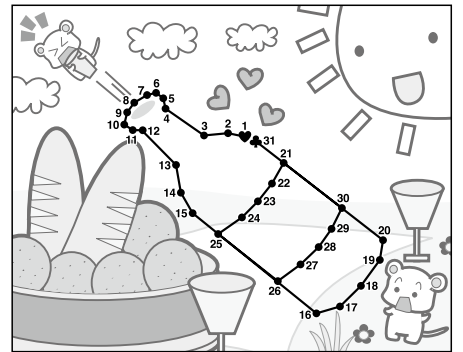

Q200 答え C アイスクリーム

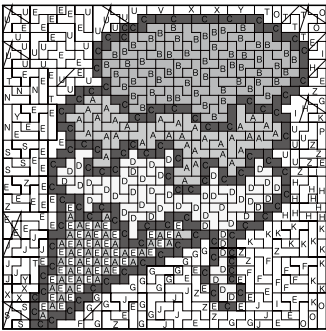

Q201 答え ロールケーキ

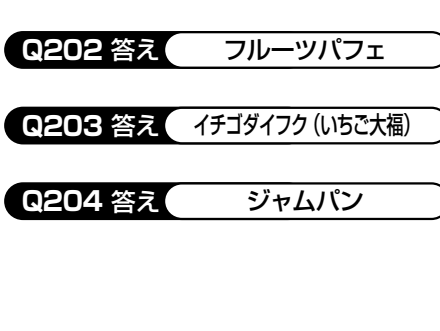

Q205 答え A 火消し

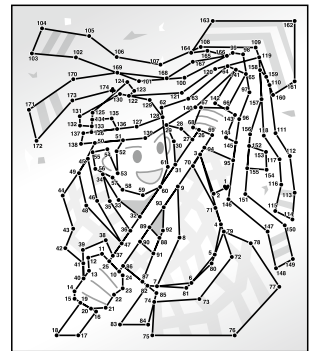

Q206 答え A プリン

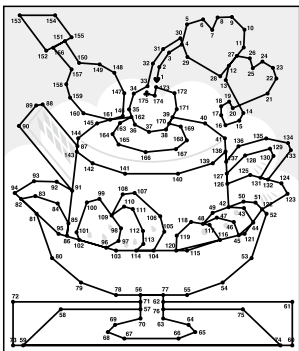

Q207 答え B タツノオトシゴ

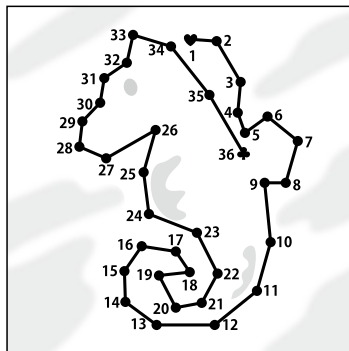

Q208 答え A 西洋ヒラギ

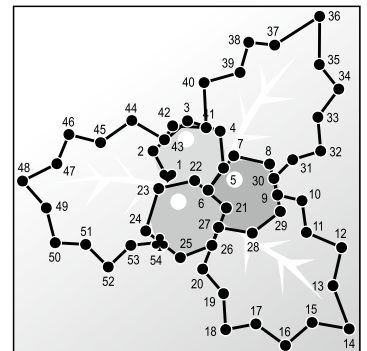

Q209 答え

C クリオネ

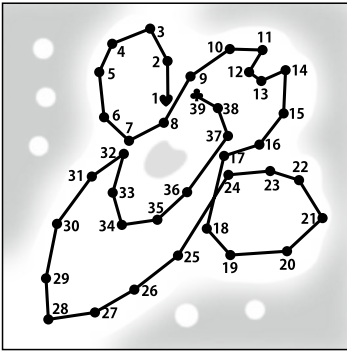

Q210 答え

A もみじ

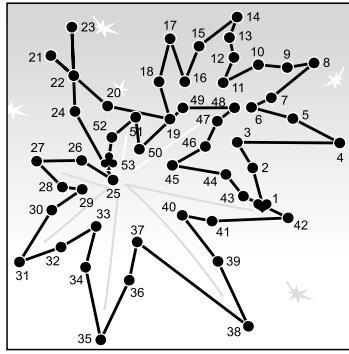

Q211 答え

A ミイラ男

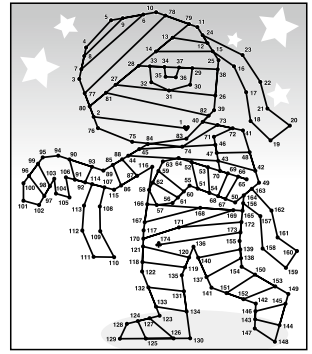

Q212 答え

A 孫悟空

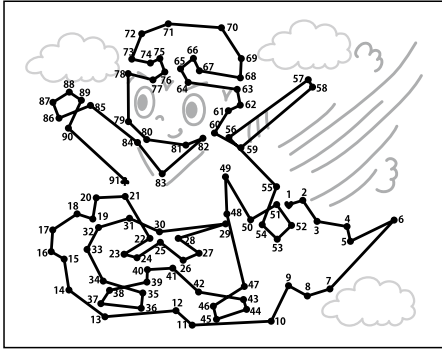

Q213 答え

B 裸の王様

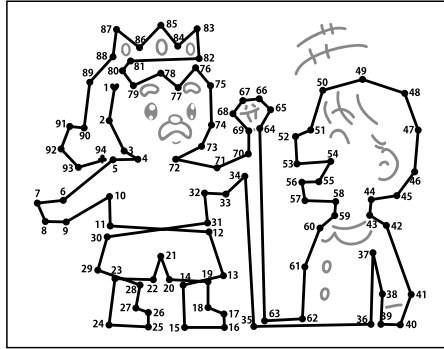

Q214 答え

B キリン

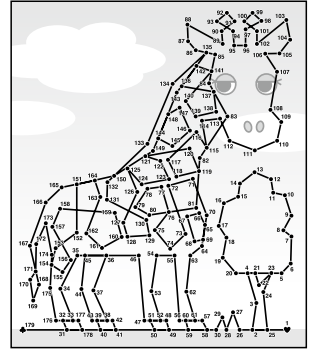

Q215 答え

B 振り子時計

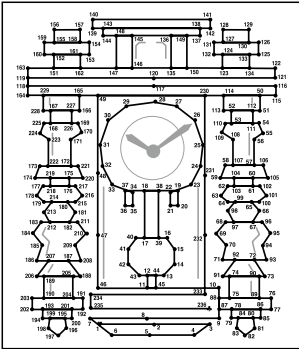

Q216 答え

C 風神と雷神

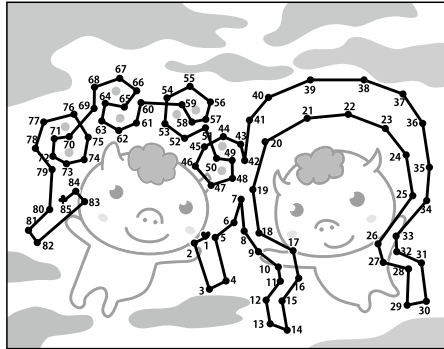

Q217 答え

C スリッパ

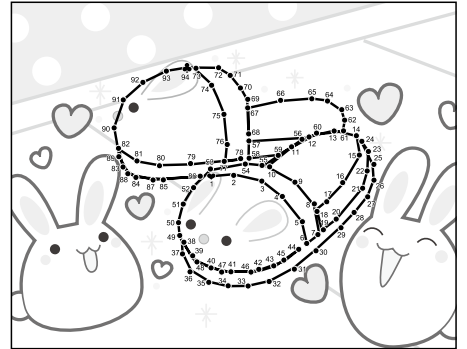

Q218 答え

A ライオン

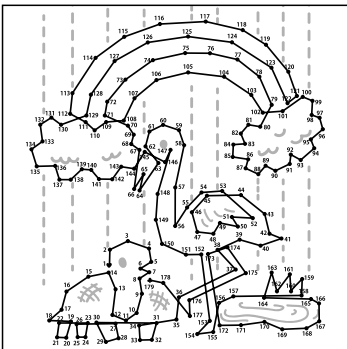

Q219 答え

A アリ

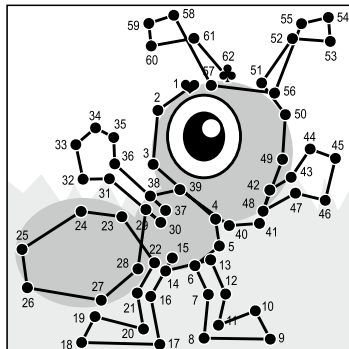

Q220 答え

B おたまじゃくし

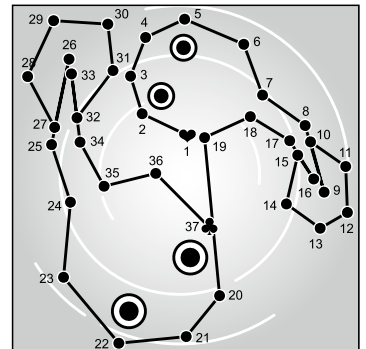

Q221 答え

C チョウ

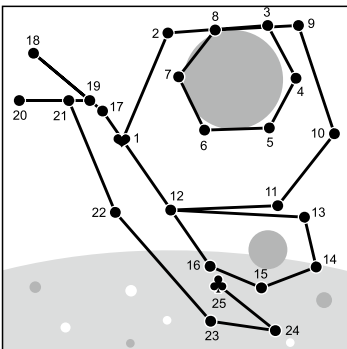

Q222 答え

A フグ

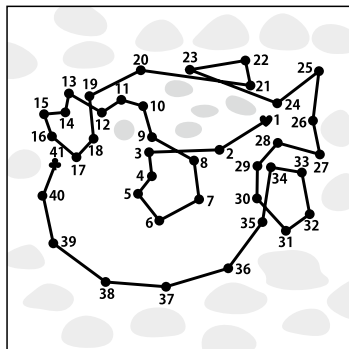

Q223 答え

B ライオン

