

Q224 答え A ピーター・パン

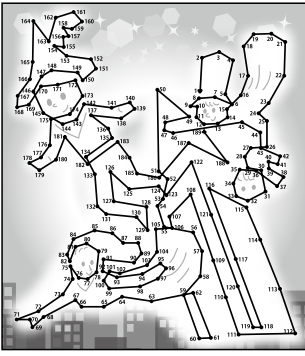

Q225 答え A ステゴサウルス

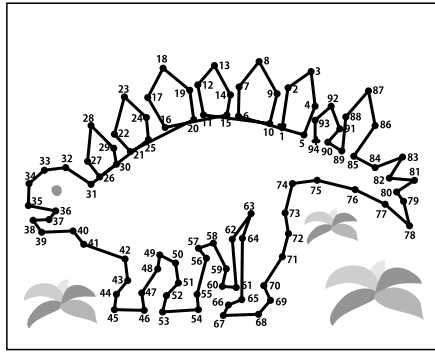

Q226 答え C パラサウロロフス

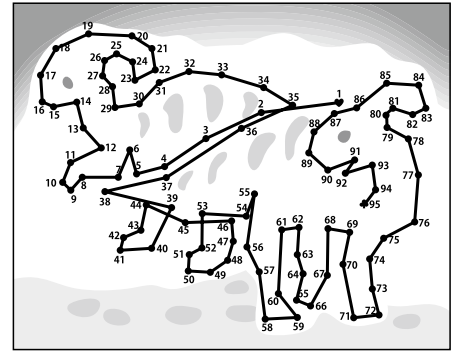

Q227 答え B ペンギン

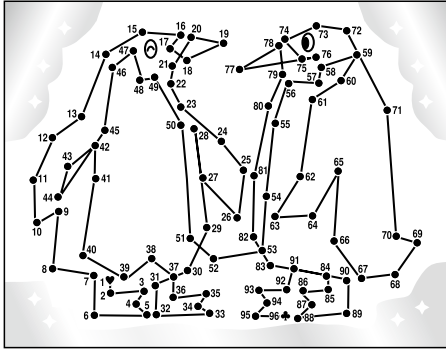

Q228 答え A カメラ

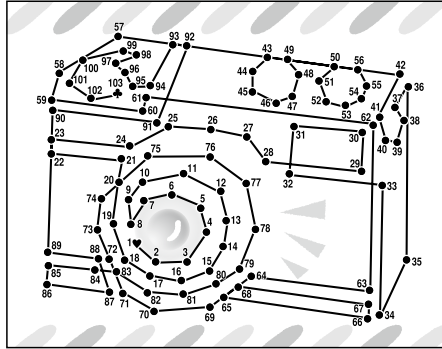

Q229 答え B シャボン玉

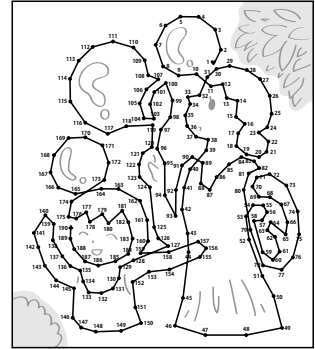

Q230 答え C 3本

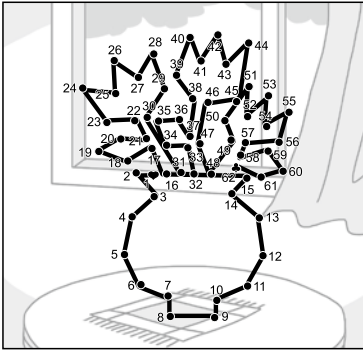

Q231 答え A クローバー

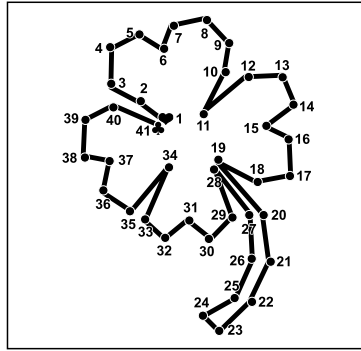

Q232 答え B 5枚

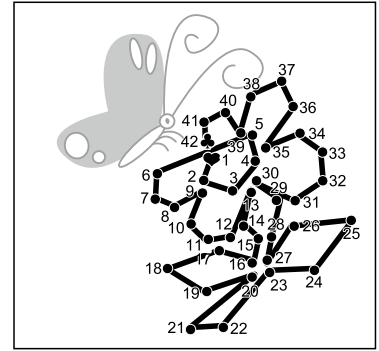

Q233 答え B インギンチャク

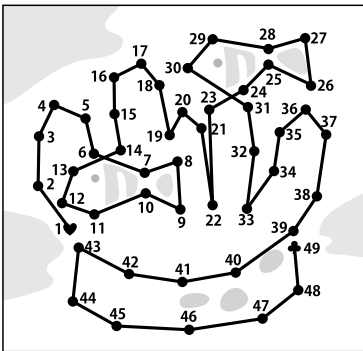

Q234 答え D



Q235 答え 2月給

Q236 答え 1 直角

Q237 答え A 言葉の前に「ち」がつく

Q238 答え B 言葉の真ん中に「い」がつく

Q239 答え B アイロン

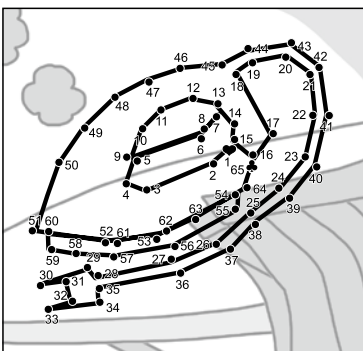

Q240 答え C ハサミ

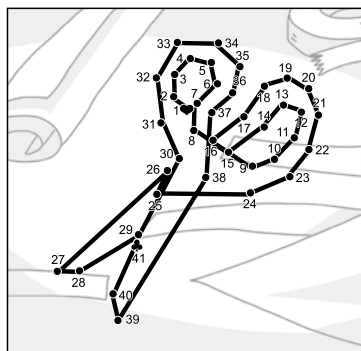

Q241 答え B バッグ

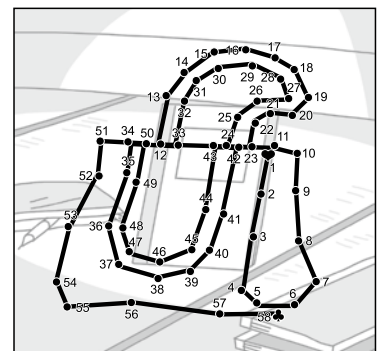

Q242 答え A ライト

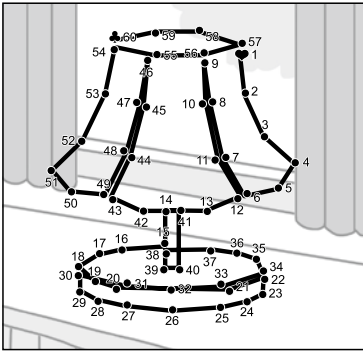

Q243 答え C おにぎり

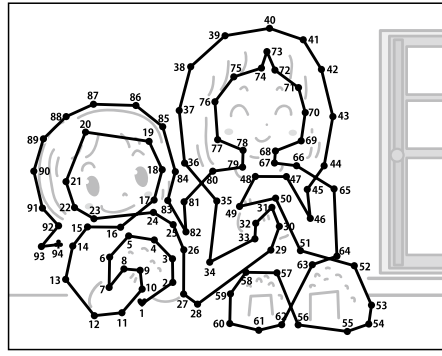

Q244 答え A 茶摘み

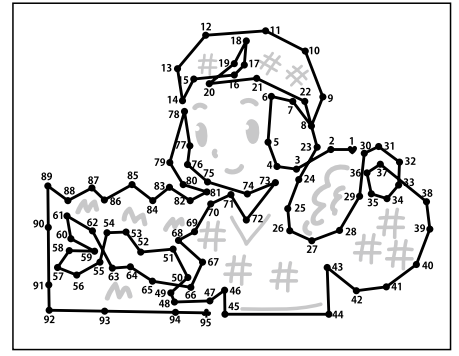

Q245 答え D ちまき

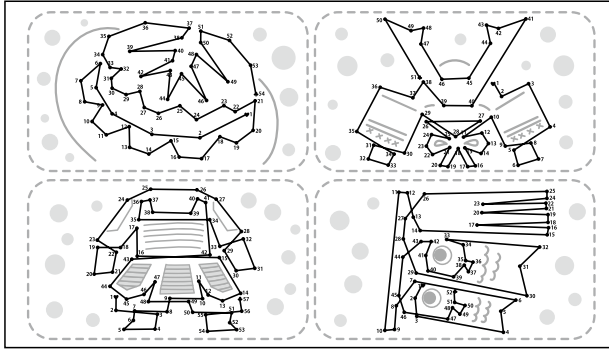

Q246 答え C イカ焼き

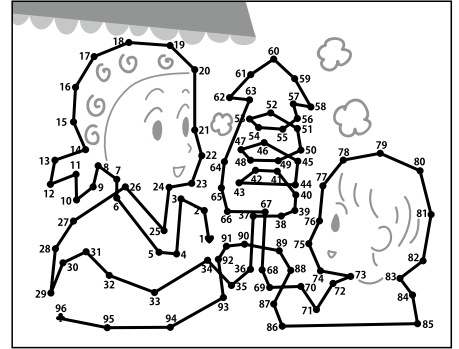

Q247 答え C 阿波踊り

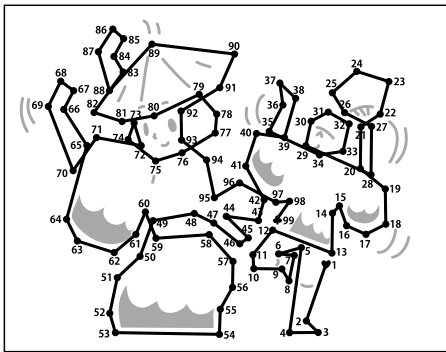

Q248 答え C 調理師

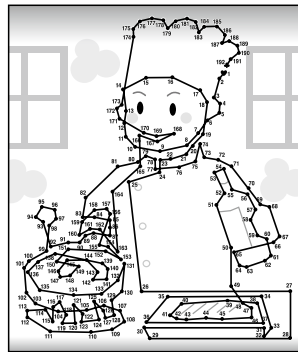

Q249 答え B 時計台

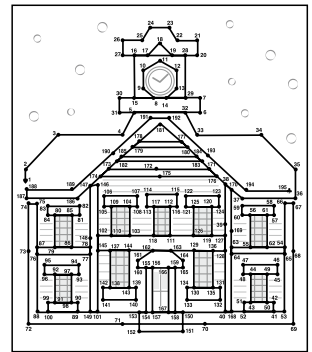

Q250 答え B 雪ん子

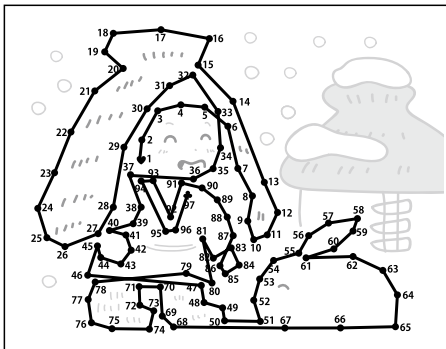

Q251 答え C こたつ

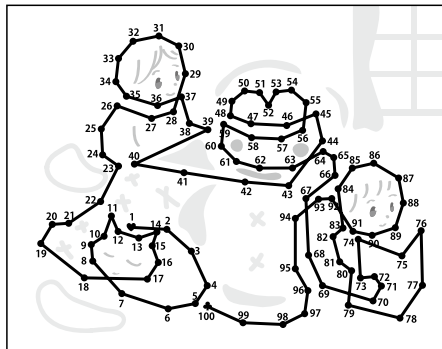

Q252 答え B ペガサス

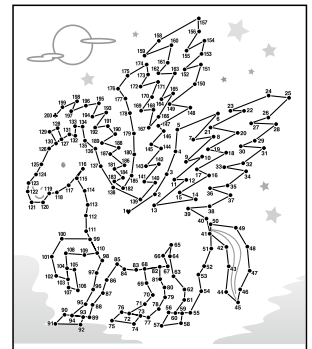

Q253 答え C ビッグ・ベン

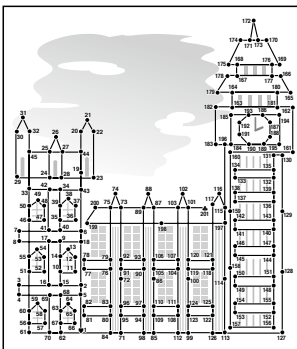

Q254 答え A エジプト

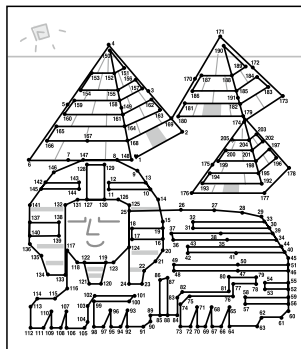

Q255 答え C チョコレート

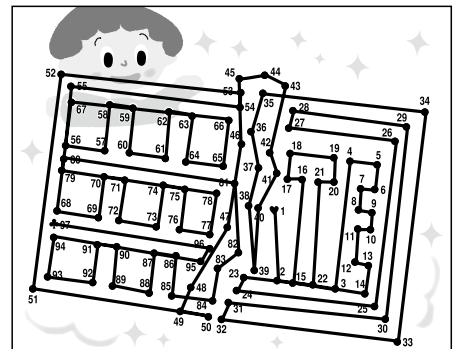

Q256 答え B ひょうたんから駒

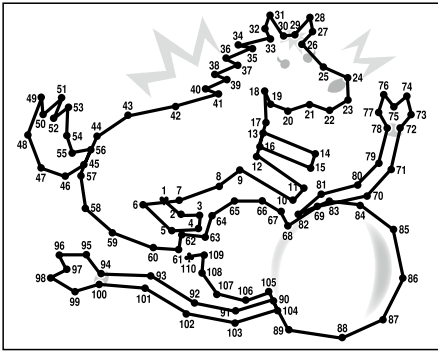

Q257 答え B 競馬

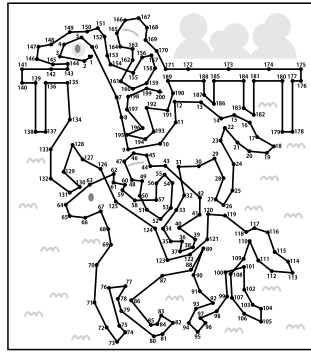

Q258 答え C 牛久大仏

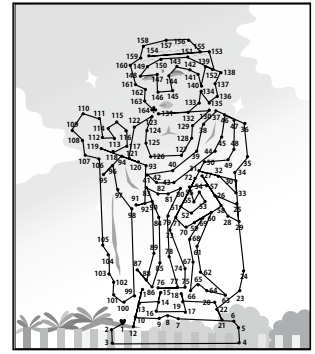

Q259 答え B



Q260 答え B 講 (受講生/大講堂)

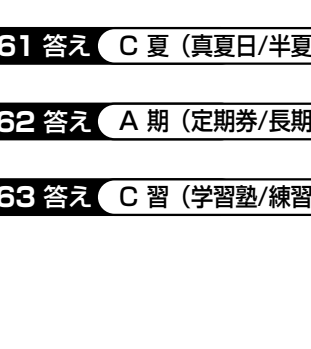

Q264 答え B シンガポール

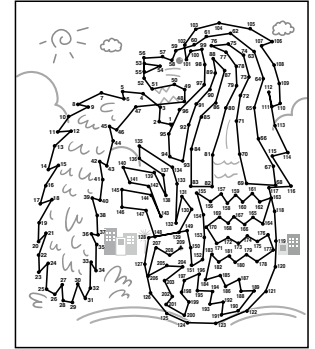

Q265 答え C サグラダ・ファミリア

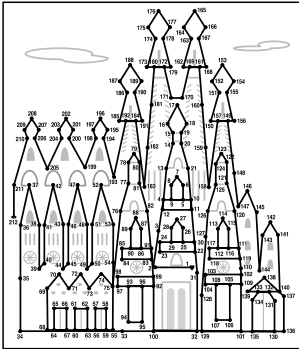

Q266 答え A 茶屋

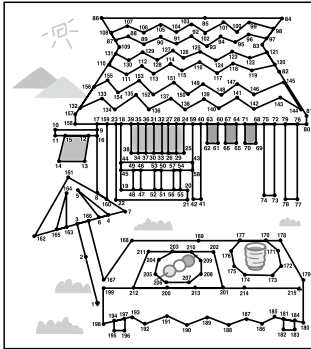

Q267 答え A ひよこ

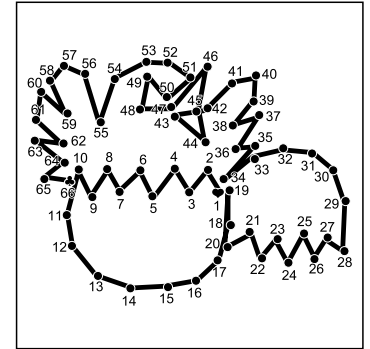

Q268 答え B ネコ

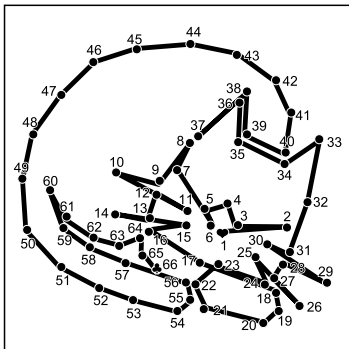

Q269 答え B カメ

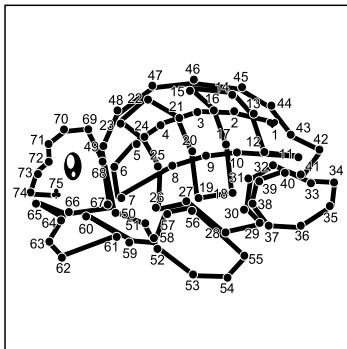

Q270 答え C リス

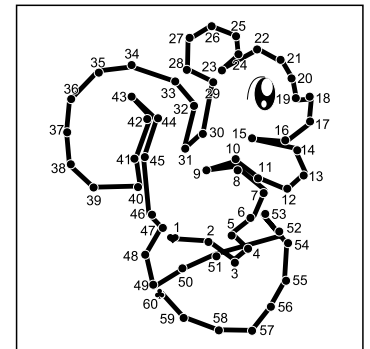

Q271 答え C 金閣寺

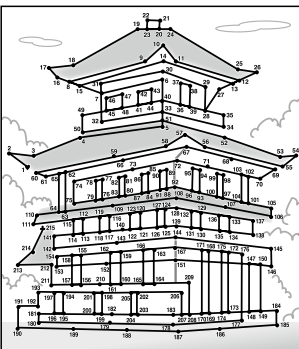

Q272 答え C オズの魔法使い

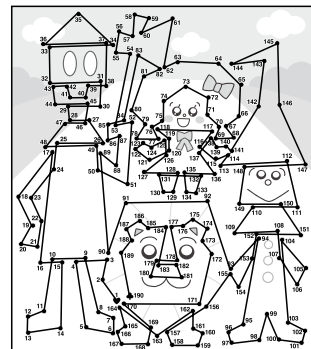

Q273 答え A 望遠鏡

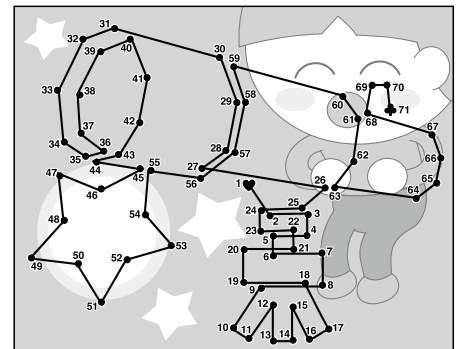



Q274 答え

A かまくら

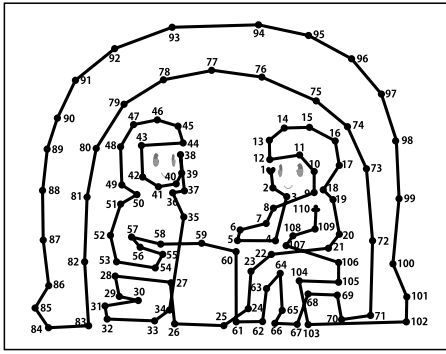

Q275 答え

A タージ・マハル

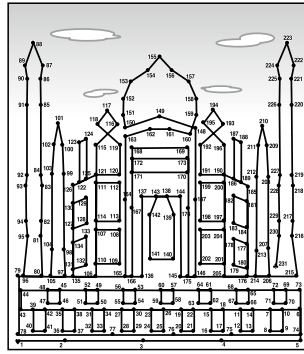

Q276 答え

C テニス

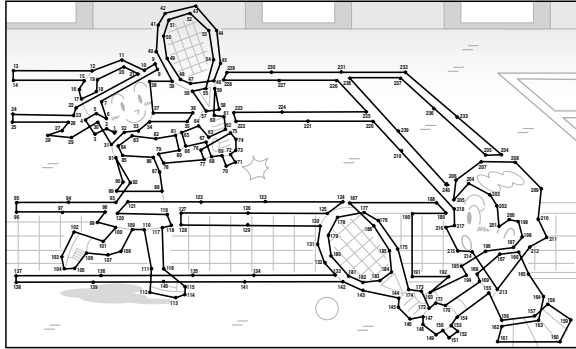

Q277 答え

C 打ち上げ花火

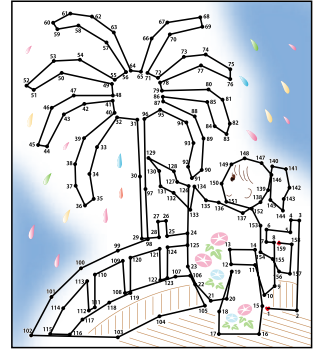

Q278 答え

A やぶさめ

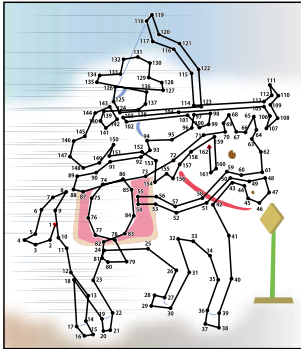

Q279 答え

B 屋台船



Q280 答え

A 植物

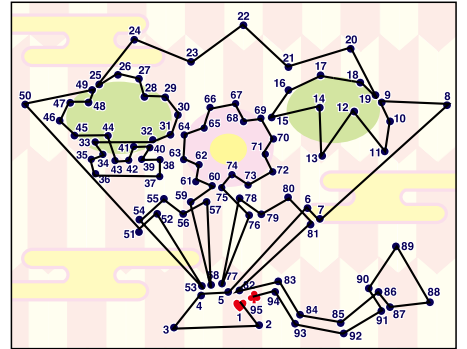

Q281 答え

B とうもろこし

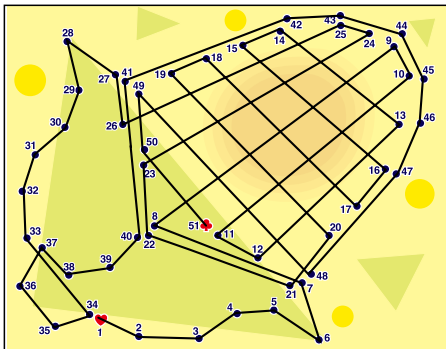

Q282 答え

C 栗

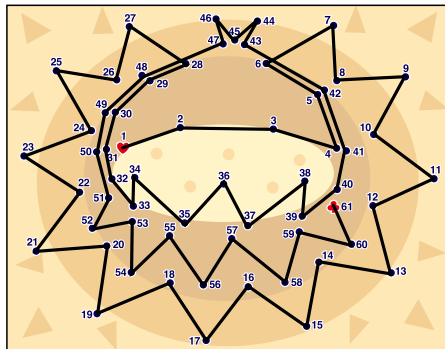

Q283 答え

A 招き猫

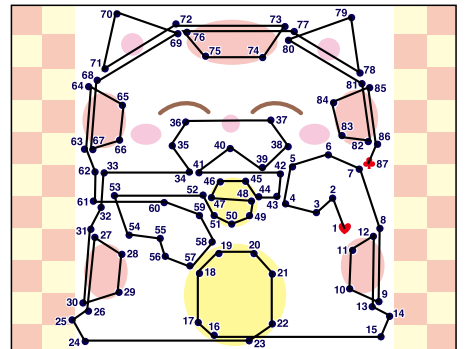

Q284 答え

B 東西の妖怪

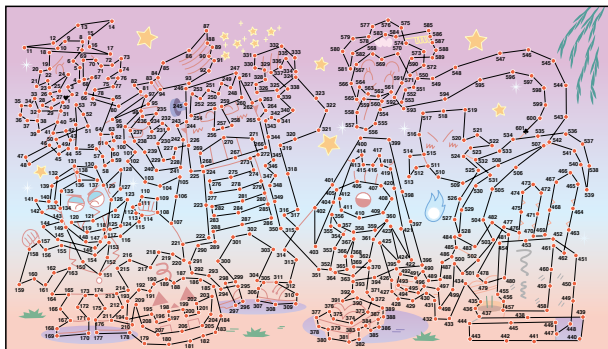

Q285 答え

B 浮世絵

